

**JEU DE CARTES AVEC LES GRAPHIES TR - CR**  
Constituez une famille de 9 cartes avec les sons tr et cr

**NOM et PRENOM :**

**Date :**



ancre

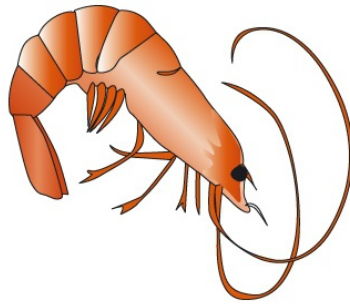

crevette

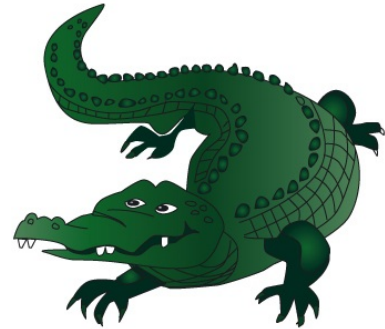

crocodile



crêpière

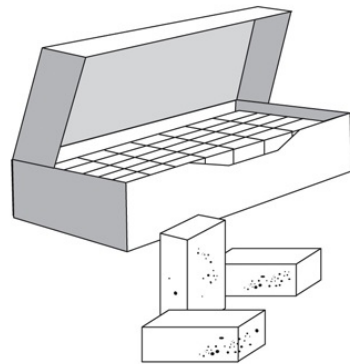

sucre

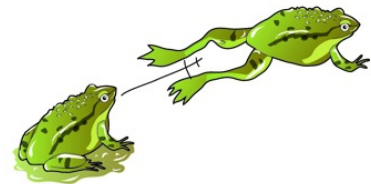

crapaud



cravate



crêche

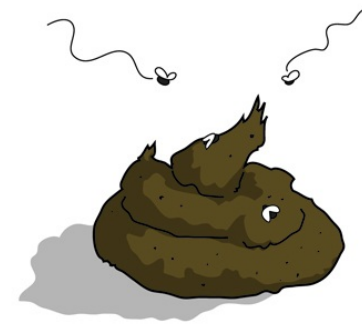

crotte

# JEU DE CARTES AVEC LES GRAPHIES TR -CR

Constituez une famille de 9 cartes avec les sons tr et cr

NOM et PRENOM :

Date :



autruche

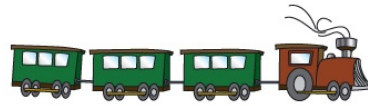

train

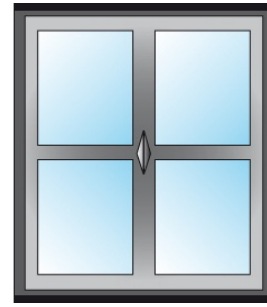

fenêtre

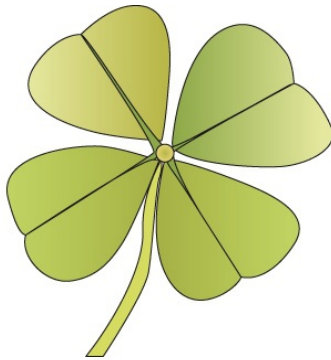

trèfle

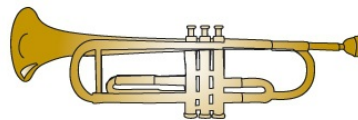

trompette



trousseau

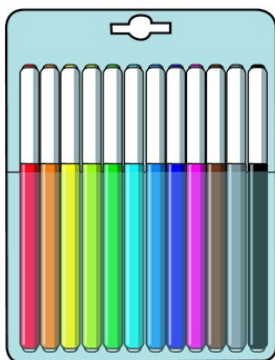

feutres



traîneau



tracteur